

Aesculap® Power Systems

Catalogue 2011

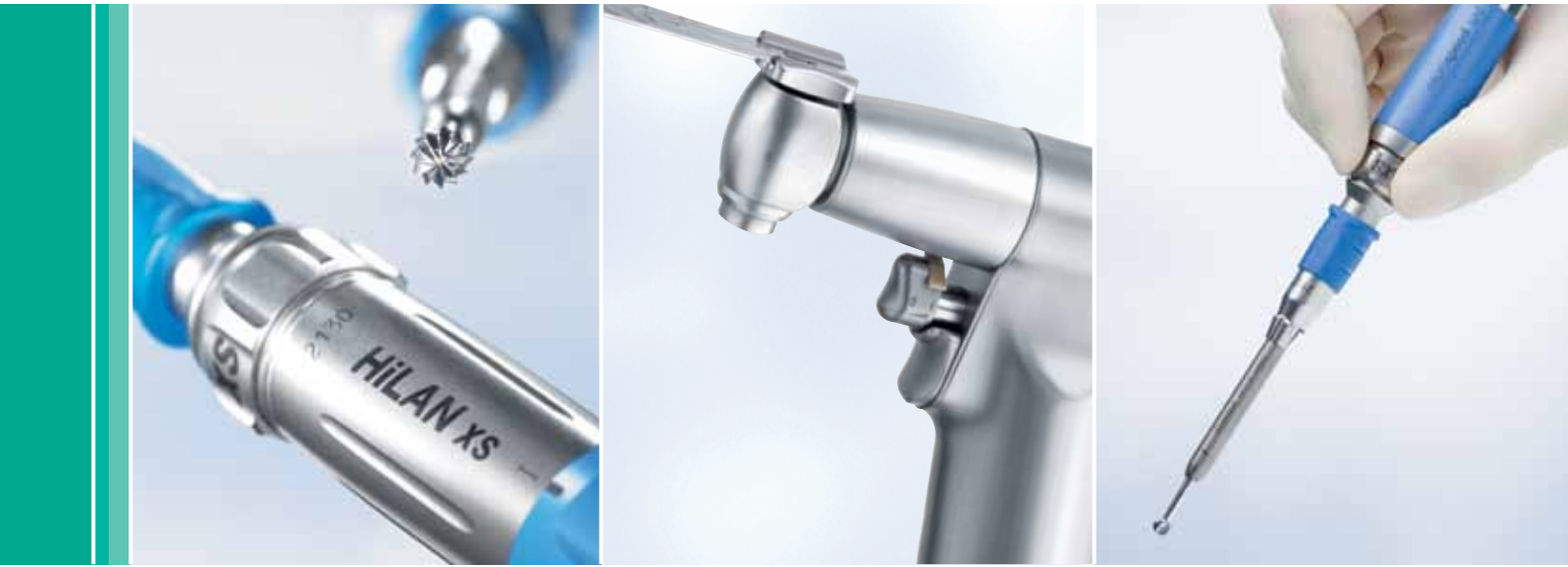

Aesculap Power Systems

Aesculap® Power Systems

Aesculap – pioneer in the field of surgical power systems.

Aesculap introduced its first surgical electric motor as early as 1904. Further important milestones followed in subsequent decades with the introduction of compressed-air systems in the 1960s, the further development of flexible cable electric motors in the 1970s, the introduction of battery-driven motors in the 1980s and the development of pneumatic and electric high speed systems in the 1990s.

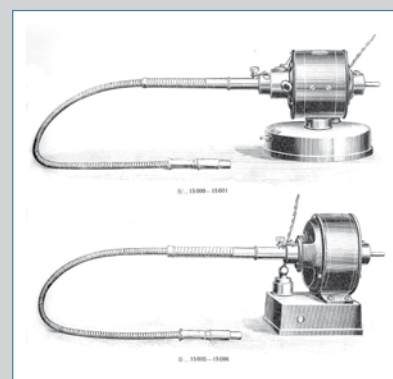
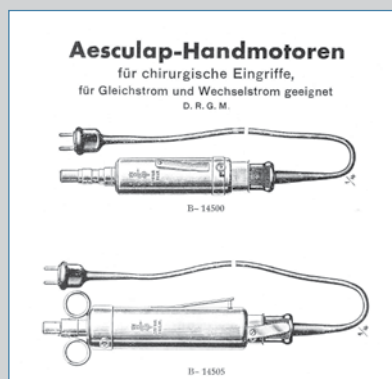

With the current systems Acculan 3Ti, HiLAN XS and microspeed uni, Aesculap offers you customized solutions for virtually all fields of application. Our system range is completed by the innovative Eccos storage system which enables timely, mechanical reprocessing of your Aesculap power systems.

Aesculap Power Systems

....get the speed you need.

How the catalogue works

1. Select motor system



GD675 **GB586R**

microspeed uni XS Hi
 High speed motor for all Hi-Line XS handpieces
 115 W; 10.000 – 80.000 1/min;
 ⚙️ ; 2,6 Ncm; 76 x 18 mm;
 📦 80 g; Latex

•••▶ **Hi-Line XS**

consisting parts:
 GB600820 Sterilit spray adaptor Hi
 GB600870 Sterilit spray adaptor XS

indicates handpiece compatibility

Electric

2. Select handpiece & Eccos holder



GB756R **GB614R**

Hi-Line XS handpiece
 1 ring code;
 spray nozzle GB761SU (not included)

article code Eccos fixation

Hi-Line XS

3. Select Tool

Use Burrs & Blades catalogue O17599



Aesculap® Burrs & Blades
 Catalogue 2010













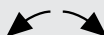

2011



Chapter Hi-Line XS burrs

Hi-Line XS

Signs and symbols

	<p>Latex-free</p> <p>all products listed in this catalogue are latex-free</p>
	Article code Eccos fixation
	Forward / reverse drive
	Forward drive
	Oscillation frequency
	Oscillation angle
	Stroke
	Cannulation
	Cable length
	Weight
	Sterile
	Single use
	Packaging Unit
	Required height of tray
	Suitable handpiece-line

Content

Power Systems

- **Electric Power Systems**
 - microspeed uni
 - microspeed arthro
 - Acculan 3Ti Electro
 - Elan EC
- **Pneumatic Power Systems**
 - HiLAN XS
- **Battery Power Systems**
 - Acculan 3Ti

Handpieces

- **Hi-Line XS**
- **micro-Line**
- **mini-Line**

Accessories

Processing

- **Sterilit Power Systems**
- **Eccos**

Index

Power Systems

Electric Power Systems

- microspeed uni
- microspeed arthro
- Acculan 3Ti Electro
- Elan EC

Pneumatic Power Systems

- HiLAN XS

Battery Power Systems

- Acculan 3Ti

Electric Power Systems

microspeed uni



Electric power system for neurosurgery, neurotology and spine

- > Versatile system for small bone surgery and arthroscopy
- > Reliable and durable due to the application of top-grade material and state-of-the art technology
- > Easy operation over touch screen and function control button
- > Compatible with handpiece lines Hi-Line XS, Hi-Line, micro-Line and mini-Line

**GD670**

microspeed uni control unit
with irrigation pump; touch screen;
power cord not included;
pump flow 0 - 80 ml/min
100-240 V AC, 50/60Hz;
305 x 305 x 175 mm; 8.300 g
consisting parts:
GD412804 bottle holder

**GD668**

microspeed uni foot control
single pedal; protection type IPx8;
anaesthetic proof class M
5.0 m;
250 x 225 x 75 mm; 2.420 g

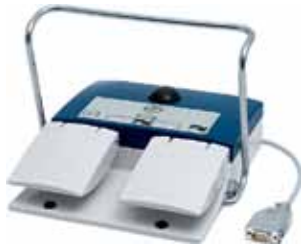
**GD671**

microspeed uni foot control
double pedal; protection type IPx8;
anaesthetic proof class M
5.0 m;
250 x 225 x 75 mm; 2.390 g

**GD672****GB689R**

microspeed uni motor cable
for use with motors GD674, GD676,
GD678, GD685
3.0 m; 360 g

**GD673****GB689R**

microspeed uni motor cable
with hand control; for use with
motors GD674, GD676, GD678,
GD685
3.0 m; 380 g

**GD676****GB578R**

microspeed uni Hi 150
high speed motor for all Hi-Line and
Hi-Line XS handpieces
150 W; 10.000 - 80.000 1/min;
3.5 Ncm; 99 x 27 mm; 155 g

•••▶ **Hi-Line, Hi-Line XS**

consisting parts:
GB600820 Sterilit spray adaptor Hi

microspeed uni



GD675 GB586R

microspeed uni XS Hi

high speed motor for all Hi-Line XS handpieces

115 W; 10.000 - 80.000 1/min; \curvearrowright \curvearrowleft ; 2.6 Ncm; 76 x 18 mm; \boxplus 80 g

•••▶ **Hi-Line XS**

consisting parts:
GB600870 Sterilit spray adaptor XS
GB600820 Sterilit spray adaptor Hi



GD685 GB587R

microspeed uni perforator driver
to use with cranial perforators with Hudson shank

150 W; 800 - 1.200 1/min; \curvearrowright ; 2.0 Nm; 155 x 41 mm; \boxplus 530 g

consisting parts:
GB600820 Sterilit spray adaptor Hi



GD678 GB578R

microspeed uni micro 150

low speed motor for all micro-Line handpieces

150 W; 1.000 - 30.000 1/min; \curvearrowright \curvearrowleft ; 7.0 Ncm; 113 x 27 mm; \boxplus 161 g

•••▶ **micro-Line**

consisting parts:
GB600810 Sterilit spray adaptor micro-Line
GB600820 Sterilit spray adaptor Hi



GD674 GB578R

microspeed uni mini 100

low speed motor for all mini-Line handpieces except of GB385R, GB388R, GB397R, GB398R

100 W; 1.000 - 16.000 1/min; \curvearrowright \curvearrowleft ; 7.0 Ncm; 95 x 27 mm; \boxplus 176 g

•••▶ **mini-Line**

consisting parts:
GB600820 Sterilit spray adaptor Hi
GB600830 Sterilit spray adaptor mini-Line



GD684 GB579R

microspeed uni pistol handpiece

low speed pistol for all mini-Line handpieces except of GB373R, GB374R, GB385R, GB397R; oscillation and tapping mode

100 W; 1.000 - 16.000 1/min; \curvearrowright \curvearrowleft ; 7.0 Ncm; \curvearrowright 2.5 mm; \curvearrowleft 3.0 m; 95 x 27 x 120 mm; \boxplus 480 g

•••▶ **mini-Line**

consisting parts:
GB600830 Sterilit spray adaptor mini-Line
GD684225 K-wire protection sleeve



GD681 GB580R

microspeed uni shaver handpiece

with hand control; for Aesculap shaver tips; variable suction; automatic tip recognition; oscillation speed adjustable 0.3 - 2.0 seconds

100 W; 400 - 8.000 1/min; \curvearrowright \curvearrowleft ; \curvearrowright 3.0 m; 150 x 27 x 37 mm; \boxplus 510 g



consisting parts:
GB600820 Sterilit spray adaptor Hi



GD682

GB580R

microspeed uni shaver handpiece
for Aesculap shaver tips; variable suction; automatic tip recognition; oscillation speed adjustable 0.3 - 2.0 seconds; to be used in combination with foot control GD671

100 W; 400 - 8.000 1/min; ;  3.0 m; 150 x 27 x 37 mm;  510 g

consisting parts:
GB600820 Sterilit spray adaptor Hi

Power cords, irrigation sets and trolleys see 'Accessories'

Electric

Electric Power Systems

microspeed arthro



Electric power system for arthroscopy and small bone surgery

- > Reliability and durability due to the application of top-grade material and state-of-the-art manufacturing technology
- > Shaver handpieces available with ergonomic two button hand control or with foot control
- > Compact and lightweight construction, with automatic tip recognition
- > Individual adjustment of oscillation frequency and acceleration and stopping characteristics
- > Large range shaver tips and burrs for excellent cutting and ablation performance



GD665
microspeed arthro control unit
 touch screen; power cord not included
 100-240 V AC, 50/60Hz;
 305 x 305 x 175 mm; 5.300 g



GD671
microspeed uni foot control
 double pedal; protection type IPx8;
 anaesthetic proof class M
 5.0 m;
 250 x 225 x 75 mm; 2.390 g



GD672 **GB689R**
microspeed uni motor cable
 for use with motors GD674, GD676,
 GD678, GD685
 3.0 m; 360 g



GD673 **GB689R**
microspeed uni motor cable
 with hand control; for use with
 motors GD674, GD676, GD678,
 GD685
 3.0 m; 380 g



GD681 **GB580R**
microspeed uni shaver handpiece
 with hand control; for Aesculap
 shaver tips; variable suction;
 automatic tip recognition;
 oscillation speed adjustable 0.3 - 2.0
 seconds
 100 W; 400 - 8.000 1/min; 3.0 m;
 150 x 27 x 37 mm;
 510 g
 consisting parts:
 GB600820 Sterilit spray adaptor Hi



GD682 **GB580R**
microspeed uni shaver handpiece
 for Aesculap shaver tips; variable
 suction; automatic tip recognition;
 oscillation speed adjustable 0.3 - 2.0
 seconds; to be used in combination
 with foot control GD671
 100 W; 400 - 8.000 1/min; 3.0 m;
 150 x 27 x 37 mm;
 510 g
 consisting parts:
 GB600820 Sterilit spray adaptor Hi

microspeed arthro



GD684 **GB579R**
microspeed uni pistol handpiece
 low speed pistol for all mini-Line handpieces except of GB373R, GB374R, GB385R, GB397R; oscillation and tapping mode
 100 W; 1.000 - 16.000 1/min; ↗ ↘; 7.0 Ncm; ⚙️ 2.5 mm; ⚙️ 3.0 m; 95 x 27 x 120 mm; 📖 480 g

•••▶️ **mini-Line**
 consisting parts:
 GB600830 Sterilit spray adaptor mini-Line
 GD684225 K-wire protection sleeve



GD678 **GB578R**
microspeed uni micro 150
 low speed motor for all micro-Line handpieces
 150 W; 1.000 - 30.000 1/min; ↗ ↘; 7.0 Ncm; 113 x 27 mm; 📖 161 g

•••▶️ **micro-Line**
 consisting parts:
 GB600810 Sterilit spray adaptor micro-Line
 GB600820 Sterilit spray adaptor Hi



GD674 **GB578R**
microspeed uni mini 100
 low speed motor for all mini-Line handpieces except of GB385R, GB388R, GB397R, GB398R
 100 W; 1.000 - 16.000 1/min; ↗ ↘; 7.0 Ncm; 95 x 27 mm; 📖 176 g

•••▶️ **mini-Line**
 consisting parts:
 GB600820 Sterilit spray adaptor Hi
 GB600830 Sterilit spray adaptor mini-Line

Power cords, irrigation sets and trolleys see 'Accessories'

Electric Power Systems

Acculan 3Ti Electro



Electric power system for orthopaedics, traumatology, cardiothoracic surgery, and dermatology

- > Powerful - up to 250 W
- > Reliable
- > Easy handling - Titanium housing allows mechanical alkaline reprocessing



GA871 **GB495R**
Acculan 3Ti Electro small drill
 with oscillation and tapping mode
 250 W; 4.0 mm;
 107 x 47 x 180 mm; 1.100 g
 consisting parts:
 GA876 adapter
 GA875 lid
 GA678 sterile funnel
 GA672211 rinsing adaptor
 GA672207 K-wire protection sleeve



GA874 **GB495R**
Acculan 3Ti Electro reciprocating saw
 250 W; 0 - 15.000 1/min;
 3.2 mm; 180 x 47 x 200 mm;
 1.540 g
 consisting parts:
 GB440215 cleaning plate
 GA876 adapter
 GA875 lid
 GA678 sterile funnel



GA870 **GB498R**
Acculan 3Ti Electro dermatome
 width keyless adjustable; thickness
 adjustable (1/10 mm steps);
 cutting thickness: 0.2 - 1.2 mm;
 cutting width: max. 78 mm;
 suitable blades GB228R (to be
 ordered separately)
 250 W; 0 - 6.500 1/min;
 3.1 mm; 290 x 110 x 90 mm;
 1.700 g
 consisting parts:
 GA876 adapter
 GA875 lid
 GA678 sterile funnel



GA873 **GB495R**
Acculan 3Ti Electro oscillating saw
 250 W; 0 - 15.000 1/min;
 4°47'; 107 x 47 x 200 mm;
 1.600 g
 consisting parts:
 GA876 adapter
 GA875 lid
 GA678 sterile funnel



GB436R **GB686R**
Protection guide
 for use with GA674, GA874 and saw
 blade GC761R



GA877
Acculan 3Ti Electro console
 power cord not included
 100-240 V AC, 50/60Hz;
 255 x 217 x 90 mm; 2.930 g

Acculan 3Ti Electro



GA878 **GB486R**
Acculan 3Ti Electro connection cable
for use with GA870, GA871, GA873, GA874
📏 3.0 m; 📖 410 g



GA876
Acculan 3Ti Electro adapter
120 x 49 x 42 mm; 📖 165 g



GA875 **GB485R**
Acculan 3Ti Electro lid



GA678 **GB488R**
Acculan 3Ti sterile funnel

Electric Power Systems

Elan EC



Universal power system for all disciplines

- > Unlimited power
- > Legendary reliability and durability
- > Easy handling
- > More than 15.000 systems installed worldwide

**GA830****Elan EC control unit**

power cord not included

100-240 V AC, 50/60Hz;
305 x 305 x 125 mm; 7.300 g**GA835****Elan EC control unit**with irrigation pump; power cord
not included;
pump flow 0 - 80 ml/min100-240 V AC, 50/60Hz;
305 x 305 x 125 mm; 7.900 gconsisting parts:
GD412804 bottle holder**GA188****Foot control**waterproof (IP67) acc. to IEC601
and DIN40050; anaesthetic proof
class M5.0 m;
130 x 200 x 60 mm; 1.900 g**GA176****GB680R****Flexible cable micro**

for all micro-Line handpieces

0 - 20.000 1/min; 1.8 m;
600 g

●●● micro-Line

**GA173****GB680R****Flexible cable micro**

for all micro-Line handpieces

0 - 20.000 1/min; 2.3 m;
700 g

●●● micro-Line

Power cords, irrigation sets and
trolleys see 'Accessories'

Pneumatic Power Systems

HiLAN XS



Power, reliability and flexibility

- > HiLAN XS, HiLAN, microLAN - Integration of high and low speed
- > The pneumatic system for all applications in microsurgery

recommended pressure for all pneumatic AESCULAP Systems is 6 - 10 bar, 85 - 145 psi (technical information at 6 bar)

HiLAN XS



GA740R GB610R

HiLAN XS

pneumatic high speed motor for all Hi-Line XS handpieces

50 W; 0 - 90.000 1/min; ↗; 2.5 Ncm; 66 x 16 mm; 📦 63 g

••• ▶ Hi-Line XS

consisting parts:
GB600820 Sterilit spray adaptor Hi

HiLAN



GA529 GB559R

HiLAN with hand control

pneumatic high speed motor for all Hi-Line and Hi-Line XS handpieces

50 W; 0 - 90.000 1/min; ↗; 2.5 Ncm; 80 x 19 mm; 📦 132 g

••• ▶ Hi-Line XS, Hi-Line

consisting parts:
GB600820 Sterilit spray adaptor Hi



GA742R GB609R

HiLAN perforator driver

with Hudson chuck

130 W; 0 - 800 1/min; ↗; 3.6 Nm; 130 x 37 mm; 📦 495 g

consisting parts:
GB600820 Sterilit spray adaptor Hi

microLAN



GA553 GB685R

microLAN 100

pneumatic motor for all micro-Line handpieces

100 W; 0 - 20.000 1/min; ↗; 8.0 Ncm; 95 x 22 mm; 📦 130 g

••• ▶ micro-Line

consisting parts:
GB600810 Sterilit spray adaptor micro-Line
GB600820 Sterilit spray adaptor Hi

Battery Power Systems

Acculan 3Ti



Acculan 3Ti is the battery-operated power system for orthopaedics, traumatology, cardiothoracic surgery, and dermatology

- > Powerful – up to 250 Watt
- > Reliable – battery and control electronic are not sterilised
- > Easy handling – Titanium housing allows mechanical alkaline reprocessing

Acculan 3Ti – the reinvention of battery power tools



GA671 **GB495R**

Acculan 3Ti small drill
with oscillation and tapping mode;
not for use with Acetabulum
reamers

220 W; ; 4.0 mm;
107 x 47 x 180 mm; 1.100 g

consisting parts:
GA666 small NiMH battery
GA675 lid
GA678 sterile funnel
GA672207 K-wire protection sleeve
GA672211 rinsing adaptor



GA672 **GB495R**

Acculan 3Ti drill and reamer

250 W; ; 4.0 mm;
107 x 47 x 200 mm; 1.250 g

consisting parts:
GA675 lid
GA676 NiMH battery
GA678 sterile funnel
GA672207 K-wire protection sleeve
GA672211 rinsing adaptor



GB635R **GB496R**

Acculan 3Ti drill attachment
with small AO chuck

0 - 1.000 1/min; 5.0 Nm;
 4.0 mm; 90 x 39 mm; 246 g



GB636R **GB496R**

Acculan 3Ti drill attachment
with Aesculap hexagonal chuck

0 - 1.000 1/min; 5.0 Nm;
 4.0 mm; 93 x 39 mm; 253 g



GB630R **GB496R**

Acculan 3Ti drill attachment
with Zimmer/Hudson chuck

0 - 1.000 1/min; 5.0 Nm;
 4.0 mm; 100 x 39 mm; 263 g





GB637R **GB496R**

Acculan 3Ti drill attachment
with trinkle chuck



0 - 1.000 1/min; 5.0 Nm;
 4.0 mm; 93 x 39 mm; 250 g

Acculan 3Ti



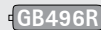

GB638R 
Acculan 3Ti drill attachment
 with Jacobs chuck 0 - 6.5 mm
 0 - 1.000 1/min; 5.0 Nm;
 4.0 mm; 110 x 39 mm;  333 g
 consisting parts:
 GB034800





GB634R 
Acculan 3Ti drill attachment
 with jacobs chuck keyless 0.6 -
 7.4 mm
 0 - 1.000 1/min; 5.0 Nm;
 4.0 mm; 125 x 39 mm;  430 g





GB643R 
Acculan 3Ti K-wire attachment
 for K-wires from 0.6 to 4.0 mm
 0 - 1.000 1/min; 93 x 36 x 137 mm;
 300 g





GB645R 
Acculan 3Ti drill attachment
 for Synthes radiolucent drive
 511.300
 0 - 900 1/min; 110 x 35 mm;
 225 g



GB654R 
Acculan 3Ti reamer attachment
 with Harris chuck
 0 - 250 1/min; 19.0 Nm;
 4.0 mm; 106 x 39 mm;  323 g

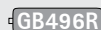

GB655R 
Acculan 3Ti reamer attachment
 with large AO chuck
 0 - 250 1/min; 19.0 Nm;
 4.0 mm; 107 x 39 mm;  334 g



GB656R **GB496R**
Acculan 3Ti reamer attachment
 with Zimmer/Hudson chuck
 0 - 250 1/min; 19.0 Nm;
 4.0 mm; 118 x 39 mm; 344 g



GB660R **GB496R**
Acculan 3Ti sagittal saw attachment
 for Acculan 3Ti rapid action saw blades with a maximum useable length of 50 mm
 0 - 17.000 1/min; 4°47';
 89 x 36 x 44 mm; 270 g



GA673 **GB495R**
Acculan 3Ti oscillating saw
 250 W; 0 - 15.000 1/min;
 4°47'; 107 x 47 x 200 mm;
 1.600 g
 consisting parts:
 GA675 lid
 GA676 NiMH battery
 GA678 sterile funnel



GA668 **GB498R**
Acculan 3Ti straight oscillating saw
 250 W; 0 - 15.000 1/min;
 4°47'; 288 x 54 x 74 mm;
 1.500 g
 consisting parts:
 GA675 lid
 GA676 NiMH battery
 GA678 sterile funnel



GA674 **GB495R**
Acculan 3Ti reciprocating saw
 250 W; 0 - 15.000 1/min;
 3.2 mm; 180 x 47 x 200 mm;
 1.540 g
 consisting parts:
 GA675 lid
 GA676 NiMH battery
 GA678 sterile funnel
 GB440215 cleaning plate



GB436R **GB686R**
Protection guide
 for use with GA674, GA874 and saw blade GC761R

Acculan 3Ti



GA670  **Acculan 3Ti dermatome**
 width keyless adjustable; thickness adjustable (1/10 mm steps); cutting thickness: 0.2 - 1.2 mm; cutting width: max. 78 mm; suitable blades GB228R (to be ordered separately)
 220 W; <<<—>—>> 0 - 6.500 1/min;
 ↑ 3.1 mm; 290 x 110 x 90 mm;
 ⚖ 1.700 g
 consisting parts:
 GA666 small NiMH battery
 GA675 lid
 GA678 sterile funnel



GA677 **Acculan 3Ti charger**
 for Acculan 3Ti batteries GA666 and GA676; 4 charging bays; avoids memory effect; automatic battery diagnosis function; with optional available charging bay GA677830 also compatible to Acculan II batteries GA616, GA626 and GA646; power cord not included
 100-240 V AC, 50/60Hz;
 440 x 140 x 180 mm; ⚖ 3.500 g



GA666 **Acculan 3Ti small NiMH battery**
 only for GA670 and GA671; with integrated electronic motor control
 9,6V ; 1,05Ah
 120 x 43 x 50 mm; ⚖ 304 g



GA676 **Acculan 3Ti NiMH battery**
 only for GA668, GA672, GA673, GA674; with integrated electronic motor control
 9,6V ; 1,95Ah
 140 x 43 x 50 mm; ⚖ 425 g



GA675  **Acculan 3Ti lid**



GA678  **Acculan 3Ti sterile funnel**



GA679



Acculan 3Ti battery removal device

Battery

Handpieces

Hi-Line XS

micro-Line

mini-Line

Hi-Line XS

Straight Hi-Line XS handpieces for the Hi-Line XS burr range



GB751R 

Hi-Line XS handpiece, straight
1 ring code;
spray nozzle GB761SU (not included)



GB752R 

Hi-Line XS handpiece, straight
2 ring code;
spray nozzle GB762SU (not included)



GB753R 

Hi-Line XS handpiece, straight
3 ring code;
spray nozzle GB763SU (not included)

Angled Hi-Line XS handpieces for the Hi-Line XS burr range



GB756R 

Hi-Line XS handpiece, angled
1 ring code;
spray nozzle GB761SU (not included)



GB757R 

Hi-Line XS handpiece, angled
2 ring code;
spray nozzle GB762SU (not included)



GB758R 

Hi-Line XS handpiece, angled
3 ring code;
spray nozzle GB763SU (not included)

Hi-Line XS

Angled Hi-Line XS handpieces for the Hi-Line XS burr range



GB771R 

Hi-Line XS handpiece, angled extra long XL1;
1 bold ring code;
spray nozzle GB764SU (not included)



GB772R 

Hi-Line XS handpiece, angled extra long XL2;
2 bold ring code;
spray nozzle GB765SU (not included)



GB773R 

Hi-Line XS handpiece, angled extra long XL3;
3 bold ring code;
spray nozzle GB766SU (not included)

Craniotome and multipurpose handpiece



GB740R  **Hi-Line XS craniotome and multi purpose handpiece**
to be used with dura guards, drill depth guard and holding sleeve GB741R - GB748R, spray nozzle GB767SU (not included)



GB741R  **Hi-Line XS dura guard**
fixed;
1 ring code;
to be used with craniotome burr GE420R, GE420SU, GE429SU



GB742R  **Hi-Line XS dura guard**
fixed;
2 ring code;
to be used with craniotome burr GE520R, GE520SU, GE529SU



GB743R  **Hi-Line XS dura guard**
fixed;
3 ring code;
to be used with craniotome burr GE620R, GE620SU, GE629SU



GB746R  **Hi-Line XS dura guard**
steerable;
1 ring code;
to be used with craniotome burr GE420R, GE420SU, GE429SU



GB747R  **Hi-Line XS dura guard**
steerable;
2 ring code;
to be used with craniotome burr GE520R, GE520SU, GE529SU

Hi-Line XS



GB748R 

Hi-Line XS dura guard
steerable;
3 ring code;
to be used with craniotome burr
GE620R, GE620SU, GE629SU



GB745R 

Hi-Line XS holding sleeve
for craniotome handpiece and
multipurpose handpiece GB740R



GB744R 

Hi-Line XS drill depth guard
for craniotome handpiece and
multipurpose handpiece GB740R
2 - 8 mm

micro-Line

For burrs with shank diameter of 2.35 mm



GB109 

micro-Line handpiece

coding: 1 blue ring;
for 51 mm burrs

1:1; 81 mm



GD450M 

micro-Line handpiece

coding: 1 blue ring;
for 70 mm burrs;
suitable spray nozzle GD460R (not
included)

1:1; 97 mm



GD451M 

micro-Line handpiece

coding: 1 blue ring;
for 95 mm burrs;

1:1; 127 mm

For burrs with shank diameter of 2,35 mm; angulation 21°



GD455M GB681R

micro-Line handpiece, angled
coding: 1 red ring;
for 70 mm burrs;
suitable spray nozzle GD460R (not
included)
1:2; 120 mm



GD456M GB681R

micro-Line handpiece, angled
coding: 1 red ring;
for 95 mm burrs;
1:2; 150 mm



GD457M GB681R

micro-Line handpiece, angled
coding: 1 red ring;
for 125 mm burrs;
1:2; 180 mm

micro-Line

For use with micro-inserts with imperator gearing, angulation 21°



GB114R  **micro-Line handpiece**
coding: 1 red ring;
suitable spray nozzle GA227R (not included)
1:2; 77 mm



GB111  **micro-Line handpiece**
coding: 1 green ring;
suitable spray nozzle GA227R (not included)
4:1; 74 mm



GB113  **micro-Line handpiece**
coding: 2 green rings;
suitable spray nozzle GA227R (not included)
30:1; 74 mm



GB173  **Imperator attachment**
for burrs with 2.35 mm diameter; up to 70 mm length; minimal shaft length 30 mm; spray nozzle GA227R (not included)
1:1; 43 mm



GB164
Mounting tool
for imperator attachment GB173



GB119  **Contra angle head**
coding: 1 green dot;
for tools with Dental shank
2:1; 43 mm



GD305  **micro-Line reciprocating saw**

keyless; suitable spray nozzle
GD306R (not included)
2,5:1; $\leftarrow\rightarrow$ 8.000 1/min; \updownarrow 1.3 mm;
348 g
consisting parts:
GD320R saw blade



GD307  **micro-Line sagittal saw**

with captive nut; suitable spray
nozzle GD308R (not included)
1:1; $\leftarrow\rightarrow$ 20.000 1/min; \angle 7°;
50 g
consisting parts:
GD372206 key



GB129  **micro-Line sagittal saw**

spray nozzle GA222R (not included)
1:1; $\leftarrow\rightarrow$ 20.000 1/min; \angle 4°46';
345 g
consisting parts:
TE472 ring spanner
GB125804 nut



GB128R  **micro-Line transversal saw**

suitable spray nozzle GA221R (not
included)
1:1; $\leftarrow\rightarrow$ 20.000 1/min; \angle 10°24';
385 g
consisting parts:
GB020R allen key



GB130R  **micro-Line reciprocating saw**

suitable spray nozzle GA223R (not
included)
1:1; $\leftarrow\rightarrow$ 20.000 1/min; \updownarrow 3.0 mm;
310 g



GB200  **micro-Line drill pistol**

spray nozzle GA221R (not included)
 \curvearrowright 20:1; \updownarrow 2.7 mm; 700 g

micro-Line



GB222

Jacobs chuck

Ø 0 - 4 mm

consisting parts:
GA062R Key



GB223

Jacobs chuck

Ø 0 - 6.5 mm

consisting parts:
GA031R key



GB224

Small AO chuck



GB227R

K-wire driver

for K-wires from 0.6 to 2.5 mm



GB231R

GB682R

micro-Line Dermatome acc. to Wagner

cutting width keyless adjustable;
thickness adjustable (1/10 mm steps);

cutting thickness: 0.2 - 1.2 mm;
cutting width: max. 78 mm

6:1; \updownarrow 3.0 mm; \boxplus 770 g

consisting parts:
GB228R blades



GB169R

GB682R

micro-Line drill

for exchangeable chucks; suitable
spray nozzle GA228R (not included)

20:1; \boxplus 280 g

consisting parts:

GC523200 ring spanner



GB106R
Hudson chuck
for GB169R



GB268R **GB682R**
micro-Line craniotome
with fixed duraguard
1:1; 200 g
consisting parts:
GB267R handpiece
GB298R fixed dura-guard
GC303R burr



GB265R **GB682R**
micro-Line craniotome
with turnable duraguard
1:1; 200 g
consisting parts:
GB266M turnable dura-guard
GB267R handpiece
GC303R burr



GB292 **GB681R**
micro-Line pediatric craniotome,
Freiburg pattern
with fixed duraguard
1:1; 100 g
consisting parts:
GB109 handpiece
GB291R dura-guard
GC304R burr

mini-Line

mini-Line



GB376R GB673R

mini-Line burr attachment

straight; for 2,35 mm shank; for burrs up to 70 mm length; suitable spray nozzle GB378 (not included)

1:2; 108 g



GB382R GB673R

mini-Line drill attachment

for tools with A0 shank; suitable spray nozzle GB378 (not included)

16:1; 98 g



GB383R GB673R

mini-Line drill attachment

Jacobs chuck; suitable spray nozzle GB378 (not included)
Ø 0 - 4 mm

16:1; 2.5 mm; 160 g

consisting parts:
GA062R Key



GB377R GB674R

mini-Line heavy duty drill attachment

Jacobs chuck; suitable spray nozzle GB378 (not included)
Ø 0 - 6.5 mm

36:1; 2.5 mm; 220 g

consisting parts:
GA031R key



GB389R GB674R

mini-Line drill attachment

with quick coupling for tools with hexagonal shank; suitable spray nozzle GB378 (not included)

36:1; 2.5 mm; 145 g





GB373R GB673R

mini-Line angled drill attachment



for tools with dental shank

8:1; 91 g



GB398R 
mini-Line K-wire attachment
for use with GD684;
for K-wires from 0.6 to 2.5 mm
16:1;  190 g



GB390R 
mini-Line sagittal saw attachment
1:1; \angle 5°;  100 g



GB392R 
mini-Line transversal saw attachment
1:1; \angle 10°;  140 g



GB374R 
mini-Line angled K-wire attachment
for use with straight mini motors;
for K-wires from 0.6 to 1.6 mm
17:1;  120 g



GB391R 
mini-Line reciprocating saw attachment
1:1; \updownarrow 2.1 mm;  100 g



GA187R 
micro-Line adaptor
handpiece: micro;
motor: mini

Accessories

Accessories for electric motors



GA411
microspeed uni mobile stand
adjustable height
┆ 1200 - 1500 mm



GA415
Mobile stand
for Elan, microspeed EC and
Microtron devices; adjustable height
┆ 1200 - 1500 mm



GD416M
Mobile stand
for AESCULAP control units
┆ 1320 mm
consisting parts:
GD414R



GD412804
Bottle holder



GA414
Sterile disposable drape
for GD417, GA419 and GD421
📦 package of 50 pieces



TE780

Power cord Europe; black

📏 1.5 m

TE730

Power cord Europe; black

📏 5.0 m

TE734

Power cord UK; black











📏 5.0 m

TE735

Power cord USA, Canada, Japan;
black

📏 3.5 m

Accessories

Wall outlet		Motor inlet		Air hoses	
		GA505R	GB564R	GA513R	GB564R
AESCULAP Dräger	small	Air hose		Air hose	
		 5.0 m		 3.0 m	
Wall outlet		Motor inlet			
		GA523R	GB564R		
AESCULAP Dräger	small	Air hose			
		(for irrigation pump GA530)			
		 2.3 m			
Wall outlet		Motor inlet			
		GA507R	GB576R		
DIN	small	Air hose			
		 5.0 m			

Wall outlet

Motor inlet



Schrader with diffuser



small

GA506R

GB575R

Air hose

5.0 m

Wall outlet

Motor inlet



AESCULAP Dräger



large

GA464R

GB463R

Air hose

3.0 m

GA466R

Air hose

5.0 m

GA460R

GB463R

Air hose, spiral type

3.0 m

Recommended pressure for all pneumatic AESCULAP Systems is 6 - 10 bar, 85 - 145 psi
 Motor connection small fits: GA502, GA508R, GA519, GA520R, GA529, GA551, GA552, GA553, GA554, GA740R, GA741R, GA742R
 Motor connection large fits: GA200, GA430, GA437, GA440, GA521, GA530

Accessories

Wall outlet

Motor inlet



DIN



large

GA463R

Air hose

3.0 m

GA465R

Air hose

5.0 m

Wall outlet

Motor inlet



DIN with diffusor



large

GA461R

Air hose

3.0 m

Wall outlet

Motor inlet



Schrader with diffusor



large

GA468R

Air hose

5.0 m

GB480R

Recommended pressure for all pneumatic AESCULAP Systems is 6 - 10 bar, 85 - 145 psi
 Motor connection small fits: GA502, GA508R, GA519, GA520R, GA529, GA551, GA552, GA553, GA554, GA740R, GA741R, GA742R
 Motor connection large fits: GA200, GA430, GA437, GA440, GA521, GA530

Wall outlet



AESCULAP Dräger

Motor inlet



AESCULAP Dräger

Extension hoses

GA194R

Extension hose

3.0 m

GA195R

Extension hose

5.0 m

Wall outlet



DIN

Motor inlet



DIN

GA087

Extension hose

5.0 m

Pneumatic accessories



GA521

Foot control

for pneumatic systems
air inlet: large
air outlet: AESUCLAP Dräger



GA099

Air pressure reducer

air pressure reducer with DIN quick lock coupling; for compressed air cylinders acc. to DIN477 G5/8" AG; air inlet 100 - 200 bar / 2130-2840 psi

consisting parts:
GA088C DIN quick lock coupler

Accessories



GA088C

Quick lock coupler
for air pressure reducer GA099; for
DIN system



GA091C

Quick lock coupler
for french system



GA508R

Angled hose adaptor
for all small Aesculap motors



GA206R

Adaptor for pneumatic systems
AESCULAP motor large - Synthes air
hoses



GA208

GB474R

Adaptor for pneumatic systems
Synthes motor - air hose with
Aesculap motor connector large

Irrigation



GA530

Irrigation pump

for pneumatic systems; to be used with tubing set GA391SU and GA526P (not included)
 pump flow 0- 80 ml/min
 100-240 V AC, 50/60Hz;
 305 x 305 x 135 mm; 5.500 g
 consisting parts:
 GD412804 bottle holder



GA391SU

Tubing Set

complete;
 including adaptor for spray nozzles, fixation clips and punch for irrigation bottle;
 for microspeed uni, Microspeed EC, Microtron EC, HiLAN (in connection with GA526P)

📦 package of 10 pieces



GA392SU

Tubing set with Y-Adaptor

complete;
 including adaptor for spray nozzles, fixations clips and punch for irrigation bottle;
 for microspeed uni

📦 package of 10 pieces



GA391

Tubing set

complete; including adaptor for spray nozzles, fixation clips and punch for irrigation bottle; for Elan (micro and mini cable only); HiLAN in connection with GA526P

📦 package of 10 pieces



GA526P

Fixation clips

for combining tubing set GA391 or GA391SU with pneumatic motors

📦 package of 8 pieces

Accessories

Adaptor



GB421R GB467R

Hudson adaptor

tool: Hudson;
motor: Harris
3.8 mm



GB422R GB467R

AO large adaptor

tool: AO large;
motor: Harris
3.8 mm



GB423R GB467R

DIN adaptor

tool: DIN;
motor: Harris
3.8 mm



GB425R GB467R

Zimmer/Hudson adaptor

tool: Zimmer/Hudson;
motor: Harris
3.8 mm



GB426R GB467R

Jacobs chuck

tool: Jacobs;
motor: Harris
Ø 0 - 6,5 mm
3.8 mm



GB628R

Synthes DHS/DCS adaptor

tool: Synthes DHS/DCS;
motor: AO large
4.2 mm



GB182R

Harris adaptor
tool: Harris;
motor: Hudson
not canulated



GB184R

Harris adaptor
tool: Harris;
motor: AO large
 3.5 mm



GB178R

Harris adaptor
tool: Harris;
motor: DIN
 3.5 mm



XF457R

DIN adaptor
tool: DIN;
motor: AO large
 3.8 mm



GB007R

AO large adaptor
tool: AO large;
motor: DIN
 4.0 mm



GB187R

Harris adaptor
tool: Harris;
motor: triangle
 3.5 mm

Accessories



GA187R GB673R

micro-Line adaptor

handpiece: micro;
motor: mini

Keys



GB034R GB690R

Key

suitable for GB223R, GB386R,
GB416R, GB426R, GB424R, GB177R,
GB638R



GA186209 GB690R

Key

for mini-coupling
suitable for GA186, GA551, GA552,
GA647, GD674, GD684



TE472 GB690R

Ring spanner

for Aesculap star coupling



GB020R GB690R

Allen Key

suitable for GB101, GB102R,
GB115R, GB121R, GB125R, GB210R,
GB230R, GB377R



GA062R

GB690R

Key

for small 4mm Jacobs chuck
suitable for GB108R, GB166R,
GB181R, GB222R, GB383R, GB415R



GD372206

Key

width across flats 6,0 mm
suitable for GD307



GC523R

Ringspanner

suitable for GA522R, GB106R,
GB108R, GB169R

Skin graft mesher



BA720R

GB688R

Skin graft mesher

for use in combination with skin
carriers BA721 (1:1,5) / BA722 (1:3)
/ BA723 (1:6)

150 x 195 x 105 mm; 4.600 g

consisting parts:
BA725R cutting roller
BA726R ratchet wrench



BA725R

Cutting roller

Accessories

Cement injection



GB141

Cement syringe
for cement injector GB171N; with
special injection tubing
50 ml
📦 package of 10 pieces



GB171N

Cement injector w. Harris shank
for disposable syringe GB141

Bone mill



GB040

Bone mill
for use with motor or crank handle
consisting parts:
GB042R crushing drum



GB042R

Crushing drum
standard; Harris shaft; section of the
produced bone chip
0.7 x 3 mm



GB043R

Crushing drum
fine; Harris shaft; section of the
produced bone chip 0.7 x 2 mm



GB044R

Crushing drum
coars; Harris shaft; section of the
produced bone chip 0.7 x 4 mm



GB041 R
Crank handle for GB040



GB046
Insert for GB040
for small bone grafts

Processing

Sterilit Power Systems

Eccos

- Eccos for Power Systems
- Eccos for handpieces
- Eccos for accessories
- Eccos sets

Sterilit Power Systems

Sterilit Power Systems



GB600

Sterilit Power Systems

300 ml

📦 package of 6 pieces



GB600810

Sterilit Power Systems spray adaptor

for micro-Line



GB600820

Sterilit Power Systems spray adaptor

for HiLAN, HiLAN XS, Hi-Line, Hi-Line XS, Microspeed EC, microspeed uni, microLAN, miniLAN



GB600830

Sterilit Power Systems spray adaptor

for mini-Line



GB600840

Sterilit Power Systems spray adaptor

for Acculan 3Ti



GB600870

Sterilit Power Systems spray adaptor

for microspeed uni XS



GA059

Sterilit drip lubricator
50 ml

The solution for storage and mechanical reprocessing of your Aesculap Power Systems

Basic requirements for mechanical reprocessing in combination with the Eccos system:

- > A suitable cleaner must be used (pH < 11 for Aluminum components)
- > The temperature in the cleaning cycle must not exceed 60°C
- > Clean for at least 3 minutes
- > Apply intermediate rinse for at least 1 minute
- > Carry out intensive final rinse with distilled, demineralised or fully desalinated water
- > Only Thermal disinfection: 5 minutes rinse at max. 96°C with distilled, demineralised or fully desalinated water
- > Complete the programme with a drying phase of at least 10 minutes at a temperature of not more than 120°

microspeed uni/microspeed arthro



GB579R
Eccos fixation
for GD684
56 mm



GB578R
Eccos fixation
for GD674, GD676, GD678
56 mm



GB689R
Eccos fixation
for GD672, GD673
56 mm



GB580R
Eccos fixation
for GD682, GD681
56 mm



GB587R
Eccos fixation
for GD685
56 mm



GB586R
Eccos fixation
for GD675
56 mm



Eccos for Power Systems

Elan EC



GB680R

Eccos fixation
for GA173, GA176

 56 mm



HiLAN XS/HiLAN



GB577R

Eccos fixation
for small Aesculap motors with
mounted angled hose adaptor
GA508R

 56 mm



GB610R

Eccos fixation
for GA740R, GA741R

 56 mm



GB609R

Eccos fixation
for GA742R, GA522R

 56 mm



microLAN

GB685R

Eccos fixation

for GA502, GA553, GA554, GD657, GD658

 56 mm



Acculan 3Ti

GB495R

Eccos fixation

for GA671, GA672, GA673, GA674, GA871, GA873, GA874

 106 mm



GB497R

Eccos fixation

for GB630R, GB634R, GB635R, GB636R, GB637R, GB638R, GB643R, GB644R, GB645R, GB654R, GB655R, GB656R, GB660R

 106 mm



GB496R

Eccos fixation

for GB630R, GB634R, GB635R, GB636R, GB637R, GB638R, GB643R, GB644R, GB645R, GB654R, GB655R, GB656R, GB660R

 106 mm



GB487R

Eccos fixation

for GA675

 56 mm



Eccos for Power Systems



GB488R
Eccos fixation
for GA678

76 mm



GB489R
Eccos fixation
for GA614, GA644, GA679

106 mm



GB498R
Eccos fixation
for GA668, GA670, GA870

106 mm



Acculan 3Ti Electro



GB485R
Eccos fixation
for GA875

56 mm



GB486R
Eccos fixation
for GA878

56 mm



Hi-Line XS



GB611R

Eccos fixation for 1 Hi-Line XS handpiece

for GB740R, GB751R, GB752R, GB753R, GB756R, GB757R, GB758R, GB771R, GB772R, GB773R

 56 mm



GB614R

Eccos fixation for 3 Hi-Line XS handpieces

for GB740R, GB751R, GB752R, GB753R, GB756R, GB757R, GB758R, GB771R, GB772R, GB773R

 56 mm



GB613R

Eccos fixation

for 13 burrs of the Hi-Line XS, Hi-Line or 2,35 mm shaft range

 36 mm

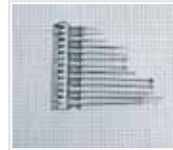

GB615R

Eccos fixation

for GB741R - GB748R

 56 mm



micro-Line



GB681R

Eccos fixation

for GB109, GB110, GB111, GB112, GB113, GB114R, GB291R, GB292R, GD305, GD307, GB310, GD450M, GD451M, GD452M, GD455M, GD456M, GD457M, GD465M, GD466M, GD467M

 56 mm



GB686R

Eccos fixation

for GB266, GB298, GB436R

 56 mm



Eccos for handpieces



GB682R

Eccos fixation

for GB128R, GB129, GB130R,
GB166R, GB169R, GB200, GB231R,
GB265R, GB267R, GB268R, GB280,
GB801R

 76 mm



mini-Line



GB673R

Eccos fixation

for GB373R, GB374R, GB376R,
GB377R, GB379R, GB380R, GB381R,
GB382R, GB383R, GB386R, GB390R,
GB391R

 56 mm



GB674R

Eccos fixation

for GB385R, GB388R, GB389R,
GB392R, GB397R, GB398R

 56 mm



Skin graft mesher



GB688R

Eccos fixation
for BA720R

 106 mm



Accessories



GB564R

Eccos fixation
for GA505R, GA513R, GA523R

 56 mm



GB463R

Eccos fixation
for GA460R, GA464R, GA466R

 76 mm



GB575R

Eccos fixation
for GA506R

 76 mm



GB576R

Eccos fixation
for GA507R

 56 mm



Eccos for accessories



GB480R

Eccos fixation
for GA468R

 76 mm



GB467R

Eccos fixation
for GB421R, GB422R, GB423R,
GB424R, GB425R

 56 mm



GB474R

Eccos fixation
for GA206R

 56 mm



GB481R

Eccos fixation
for saw blades and other accessories

 56 mm



GB572R

Eccos fixation
for GB300R - GB308R

 56 mm



GB690R

Eccos fixation
for GB173R, GB119, GB154, GB194,
GB628R, GA031201, GB424201,
GA437224, GB009C

 36 mm





GB459R

Eccos Montageset

Eccos sets

Acculan 3Ti

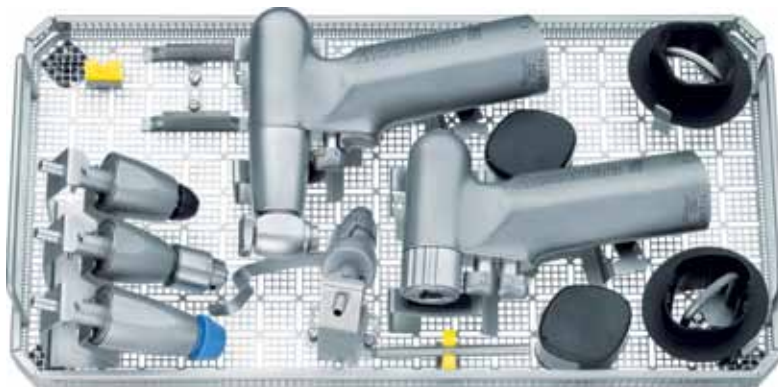

GB243R

Eccos Set for 2 Acculan 3Ti machines

 106 mm

consisting parts:

GB243800

GB481R

GB487R

GB488R

GB495R

GB496R

GB497R

GB690R



GB244R

Eccos Set for 1 Acculan 3Ti machine

 106 mm

consisting parts:

GB243800

GB481R

GB487R

GB488R

GB495R

GB496R

GB497R

GB690R



GB256R

Eccos Set for Acculan 3Ti dermatome

 106 mm

consisting parts:

GB487R

GB488R

GB498R

JC254R

microspeed uni



GB255R

Eccos Set for microspeed uni Neurosurgery

 56 mm

consisting parts:

GB586R

GB587R

GB614R

GB615R

GB689R

JF212R



GB254R

Eccos Set for microspeed uni small bone surgery

 56 mm

consisting parts:

GB579R

GB673R

GB674R

GB690R

JF212R

HiLAN XS

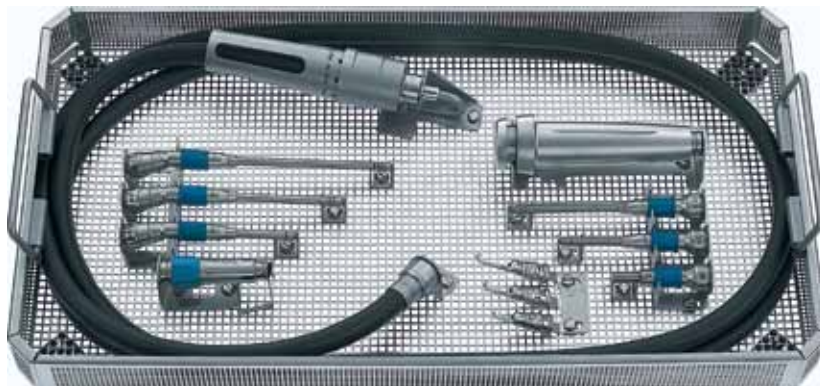

GB252R

Eccos Set for HiLAN XS

 56 mm

consisting parts:

GB564R

GB609R

GB610R

GB614R

GB615R

JF213R

Index

Index by reference numbers

BA720R	57	GA676	28	GB243R	74	GB587R	65
BA725R	57	GA677	28	GB244R	74	GB600	62
		GA678	18,28	GB252R	75	GB600810	62
GA059	63	GA679	29	GB254R	75	GB600820	62
GA062R	57	GA740R	23	GB255R	75	GB600830	62
GA087	51	GA742R	23	GB256R	74	GB600840	62
GA088C	52	GA830	21	GB265R	43	GB600870	62
GA091C	52	GA835	21	GB268R	43	GB609R	66
GA099	51	GA870	17	GB292	43	GB610R	66
GA173	21	GA871	17	GB373R	44	GB611R	69
GA176	21	GA873	17	GB374R	45	GB613R	69
GA186209	56	GA874	17	GB376R	44	GB614R	69
GA187R	45,56	GA875	18	GB377R	44	GB615R	69
GA188	21	GA876	18	GB382R	44	GB628R	54
GA194R	51	GA877	17	GB383R	44	GB630R	25
GA195R	51	GA878	18	GB389R	44	GB634R	26
GA206R	52			GB390R	45	GB635R	25
GA208	52	GB007R	55	GB391R	45	GB636R	25
GA391	53	GB020R	56	GB392R	45	GB637R	25
GA391SU	53	GB034R	56	GB398R	45	GB638R	26
GA392SU	53	GB040	58	GB421R	54	GB643R	26
GA411	46	GB041R	59	GB422R	54	GB645R	26
GA414	46	GB042R	58	GB423R	54	GB654R	26
GA415	46	GB043R	58	GB425R	54	GB655R	26
GA460R	49	GB044R	58	GB426R	54	GB656R	27
GA461R	50	GB046	59	GB436R	17,27	GB660R	27
GA463R	50	GB106R	43	GB459R	73	GB673R	70
GA464R	49	GB109	38	GB463R	71	GB674R	70
GA465R	50	GB111	40	GB467R	72	GB680R	66
GA466R	49	GB113	40	GB474R	72	GB681R	69
GA468R	50	GB114R	40	GB480R	72	GB682R	70
GA505R	48	GB119	40	GB481R	72	GB685R	67
GA506R	49	GB128R	41	GB485R	68	GB686R	69
GA507R	48	GB129	41	GB486R	68	GB688R	71
GA508R	52	GB130R	41	GB487R	67	GB689R	65
GA513R	48	GB141	58	GB488R	68	GB690R	72
GA521	51	GB164	40	GB489R	68	GB740R	35
GA523R	48	GB169R	42	GB495R	67	GB741R	35
GA526P	53	GB171N	58	GB496R	67	GB742R	35
GA529	23	GB173	40	GB497R	67	GB743R	35
GA530	53	GB178R	55	GB498R	68	GB744R	36
GA553	23	GB182R	55	GB564R	71	GB745R	36
GA666	28	GB184R	55	GB572R	72	GB746R	35
GA668	27	GB187R	55	GB575R	71	GB747R	35
GA670	28	GB200	41	GB576R	71	GB748R	36
GA671	25	GB222	42	GB577R	66	GB751R	32
GA672	25	GB223	42	GB578R	65	GB752R	32
GA673	27	GB224	42	GB579R	65	GB753R	32
GA674	27	GB227R	42	GB580R	65	GB756R	33
GA675	28	GB231R	42	GB586R	65	GB757R	33



Aesculap AG | Am Aesculap-Platz | 78532 Tuttlingen | Germany
Phone +49 (0) 74 61 95-0 | Fax +49 (0) 74 61 95-26 00 | www.aesculap.com

Aesculap – a B. Braun company

The main product mark 'Aesculap' is a registered mark of Aesculap AG.

Subject to technical changes. All rights reserved.
This brochure may only be used for the exclusive purpose of obtaining information about our products. Reproduction in any form partial or otherwise is not permitted.

Brochure No. 022702

0111/3.5/3